

Standard Probe, 4mm

Features

- Accepts All Industry Standard 4mm Test Lead Plugs
- Socket to Rear



NTE Type No.	Color	Diag No.
72-012	Black	TL-002
72-013	Red	TL-002
72-013-KIT	Contains 1 ea. of 72-012 & 72-013	

TL-002

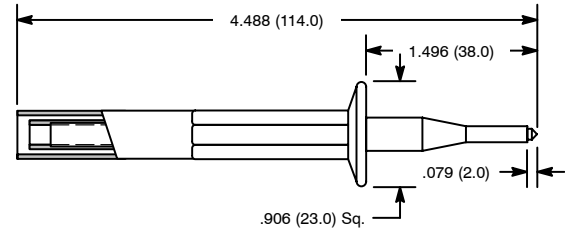

Specifications

IEC 1010 Rating: 1000V CAT3 □ 30 Amps

NEW

OEM Style Probe, 4mm

Features

- Accepts All Industry Standard 4mm Test Lead Plugs
- Extremely Sharp, Stainless Steel Point
- Socket to Rear



NTE Type No.	Color	Diag No.
72-049 (Replaced by 72-178-0)	Black	TL-003
72-050 (Replaced by 72-178-2)	Red	TL-003
72-050-KIT	Contains 1 ea. of 72-049 & 72-050	

TL-003

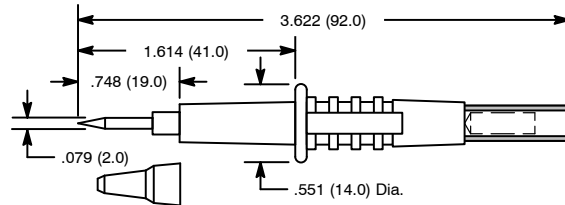

Specifications

IEC 1010 Rating: 1000V CAT3 / 600V CAT4 □ 30 Amps

NEW

Long Reach Probe, 4mm

Features

- Accepts All Industry Standard 4mm Test Lead Plugs
- Socket to Rear



NTE Type No.	Color	DiagNo.
72-014	Black	TL-004
72-015	Red	TL-004
72-015-KIT	Contains 1 ea. of 72-014 & 72-015	

TL-004



Specifications

IEC 1010 Rating: 1000V CAT3 □ 20 Amps

NEW

Thin Spike Probe, 4mm

Features

- Accepts All Industry Standard 4mm Test Lead Plugs
- Designed for Precise Probing



NTE Type No.	Color	Diag No.
72-020	Black	TL-005
72-021	Red	TL-005
72-021-KIT	Contains 1 ea. of 72-020 & 72-021	

TL-005

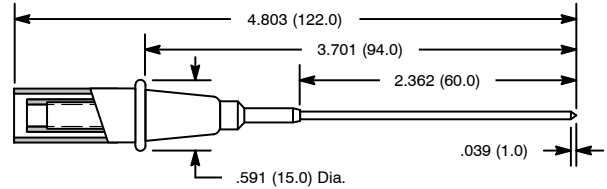

Specifications

IEC 1010 Rating: 1000V CAT3 / 600V CAT4 □ 10 Amps

NEW

Long Tip Probe, 4mm

Features

- Accepts All Industry Standard 4mm Test Lead Plugs
- 2mm Dia. Probe to Front
- Socket to Rear



NTE Type No.	Color	Diag No.
72-010	Black	TL-006
72-011	Red	TL-006
72-011-KIT	Contains 1 ea. of 72-010 & 72-011	

TL-006

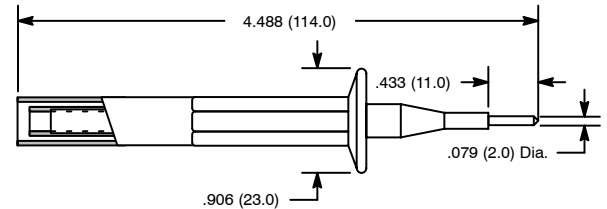

Specifications

IEC 1010 Rating: 1000V CAT2 □ 30 Amps

NEW

Lantern Probe, 4mm

Features

- Accepts All Industry Standard 4mm Test Lead Plugs
- Lantern Probe Tip
- Socket to Rear

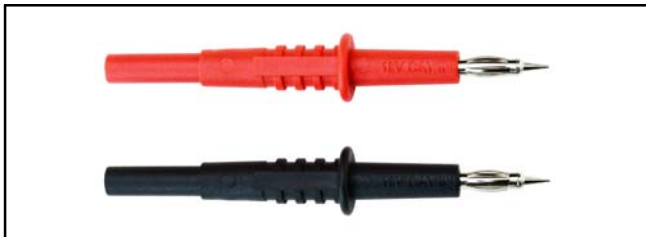

NTE Type No.	Color	Diag No.
72-018	Black	TL-007
72-019	Red	TL-007
72-019-KIT	Contains 1 ea. of 72-018 & 72-019	

TL-007

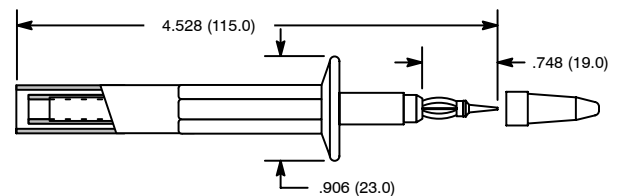

Specifications

IEC 1010 Rating: 1000V CAT3 □ 20 Amps

NEW

Fused Modular Probe, 4mm

Features

- Accepts All Industry Standard 4mm Test Lead Plugs
- Fused Probe Protects User From Shock, Even if the Instrument is Fused
- Fuse is Easily Serviced Without the Use of Tools



NTE Type No.	Color	Replacement Fuse	Diag No.
72-022	Black	72-002	TL-008
72-023	Red	72-002	TL-008
72-023-KIT	Contains 1 ea. of 72-022 & 72-023		

TL-008

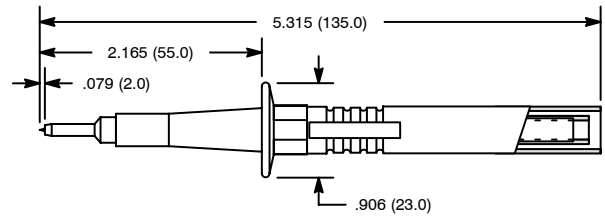

Specifications

IEC 1010 Rating: 1000V CAT3 / 600V CAT4 □ 0.5 Amps
 Fuse Rating: 500mA/1000V/50kA

North American Line Power Receptacle Test Adaptor

Features

- UL/CSA Compliant
- Accepts All Industry Standard 4mm Test Lead Plugs
- Bladed Probes Assure Sound Electrical Contact with Standard A/C Receptacles



NTE Type No.	Color	Diag No.
72-024	Black	TL-016
72-025	Red	TL-016
72-025-KIT	Contains 1 ea. of 72-024 & 72-025	

TL-016

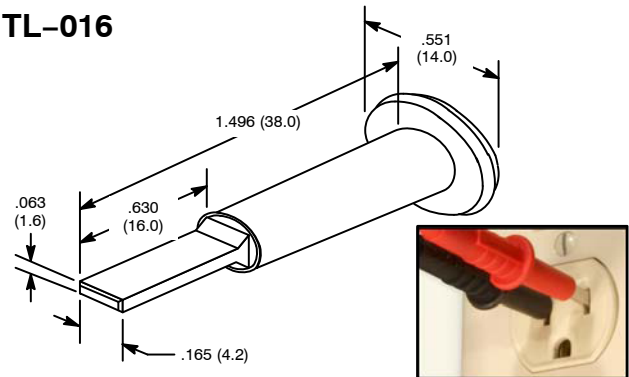

Specifications

IEC 1010 Rating: 1000V CAT3 / 600V CAT4 □ 20 Amps

Sprung Hook, 4mm

Features

- Accepts All Industry Standard 4mm Test Lead Plugs
- Ideal for Hands-Free Connection to IC Legs and Small Conductors

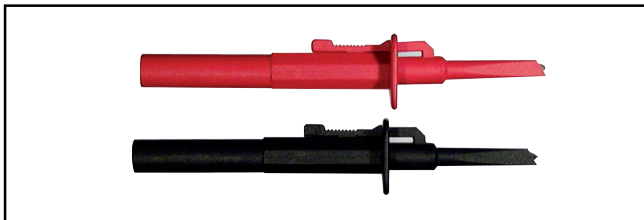

NTE Type No.	Color	Diag No.
72-016	Black	TL-009
72-017	Red	TL-009
72-017-KIT	Contains 1 ea. of 72-016 & 72-017	

TL-009

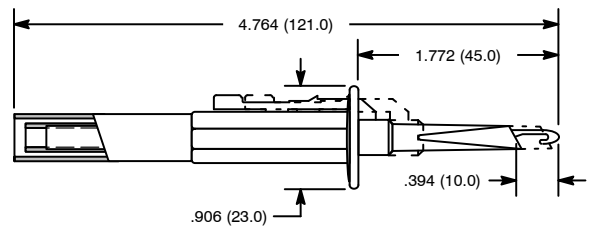

Specifications

IEC 1010 Rating: 1000V CAT3 / 600V CAT4 □ 20 Amps

Safety Plunger Clip Adapter, 4mm

Features

- Accepts All Industry Standard 4mm Test Lead Plugs
- 8-32 UNC Thread



TL-026

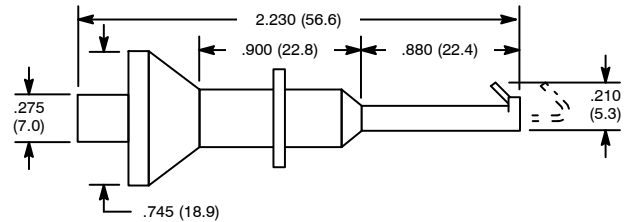

NTE Type No.	Color	Diag No.
72-177-0	Black	TL-026
72-177-2	Red	TL-026

Specifications

Rating: 1000V, 15 Amps

Plunger Clip

Features

- Beryllium Copper Contact Insulated to a Single Contact Point

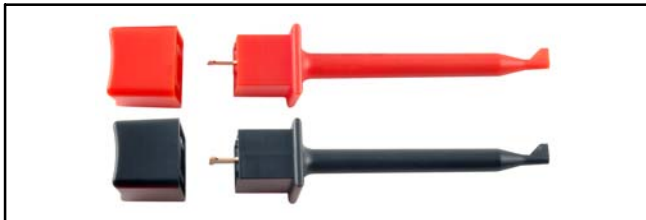

TL-031

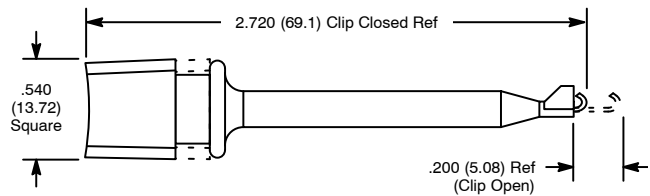

NTE Type No.	Color	Diag No.
72-183-0	Black	TL-031
72-183-2	Red	TL-031

Specifications

Rating: 1000V, 10 Amps

Right Angle Insulated Plunger Hook Clip, 4mm

Features

- Accepts All Industry Standard 4mm Test Lead Plugs
- Fast and Easy Connection to Terminal and Component Test Leads



TL-028

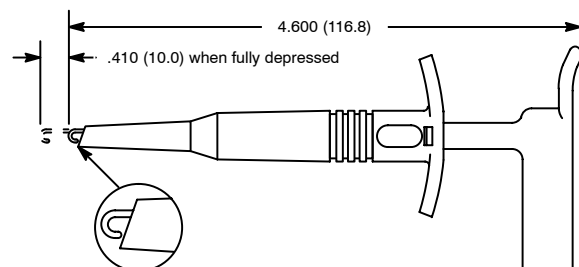

NTE Type No.	Color	Diag No.
72-180-0	Black	TL-028
72-180-2	Red	TL-028

Specifications

IEC 1010 Rating: 1000V, 15 Amps

Insulated Plug-On Test Probe, 4mm

Features

- Accepts All Industry Standard 4mm Test Lead Plugs
- 8-32 UNC Thread



TL-027

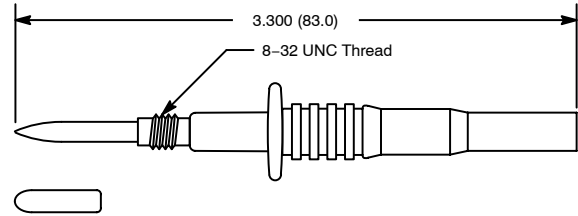

Specifications

IEC 1010 Rating: 1000V, 20 Amps

	NTE Type No.	Color	Diag No.
NEW	72-178-0	Black	TL-027
NEW	72-178-2	Red	TL-027